

# CLUB TABLE & BENCH

Jennifer Newman

## Features:

- Robust surface and frame
- Solid oak (Butchers block) option
- Tough hard-wearing materials
- Bespoke colours
- Handmade in our UK workshop
- 5 year warranty

## Environmental:

- British manufacture
- FISP accredited
- FSC accredited
- 86% recycled steel
- Durable materials

## Installation:

- Delivered disassembled.
- Full assembly instructions provided.



Birch ply surface (solid oak available). Steel legs powder-coated colour RAL 9010.

## Dimensions & Weight

All dimensions in mm.

W	D	H	kg
Table			
1800	900	750	78

W	D	H	kg
Bench			
1500	350	450	29

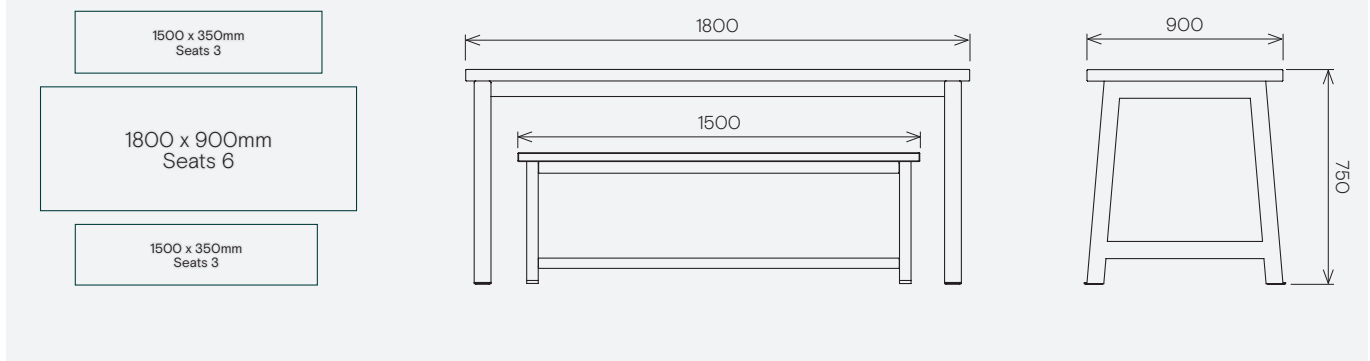







## Legs (inside only) Powder-coated finishes

lacquer sealed

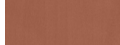
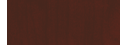
 <b>Sable</b> BS 04-B-21	 <b>Oxide Red</b> RAL 3009	 <b>Cream</b> RAL 9001	 <b>Agate Grey</b> RAL 7038
 <b>Light Blue</b> BS 18-C-35	 <b>Black</b> RAL 9004	 <b>Bronze</b>	 <b>Gunmetal</b>

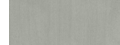
## Surfaces (inside only) Birch ply / Oak (butchers block)

lacquer sealed

 <b>Sable</b>	 <b>Oxide Red</b>	 <b>Cream</b>	 <b>Agate Grey</b>
 <b>Light Blue</b>	 <b>Black</b>	 <b>Bronze</b>	 <b>Birch / Oak</b>